

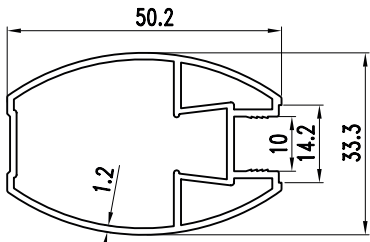

Aluminium-Profile



Vertikale Profile für Schiebetür-Systeme



BG 021

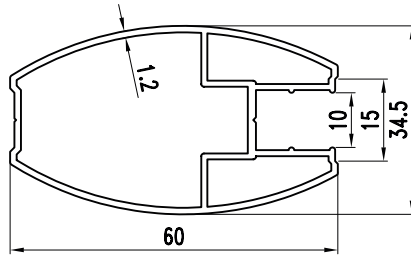

BG 006

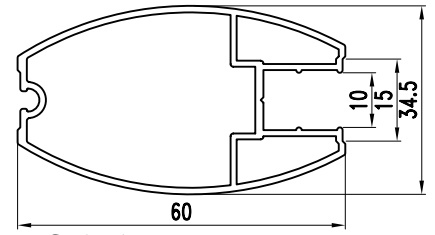

BG-056

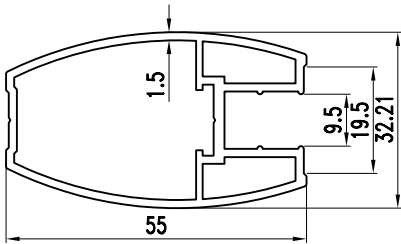

BG-040

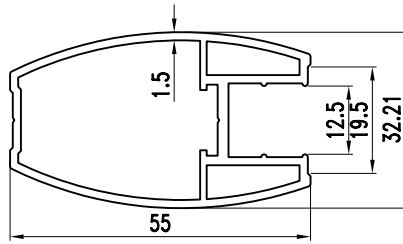

BG-041

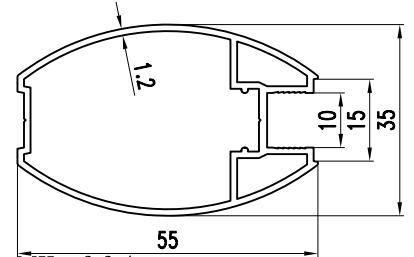

MK 004

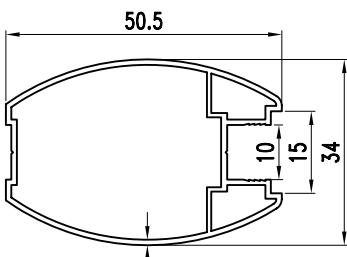

MK 177

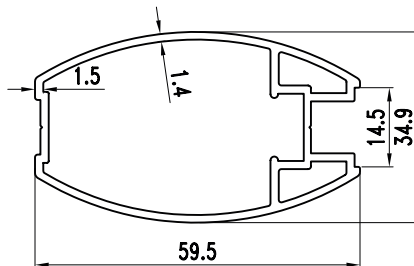

MK 203

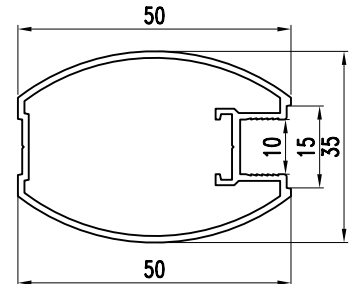

MK 106

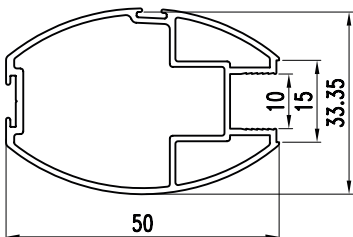

MK 195

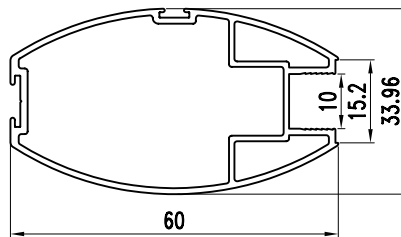

MK 196

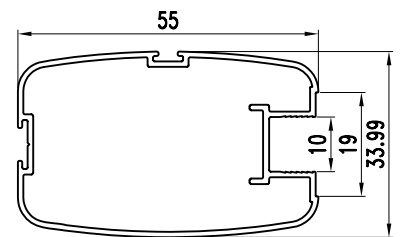

MK-270

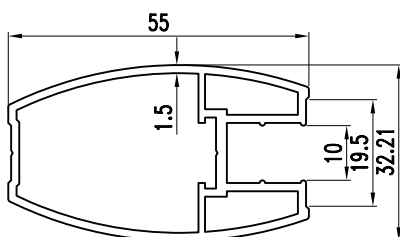

BG-051

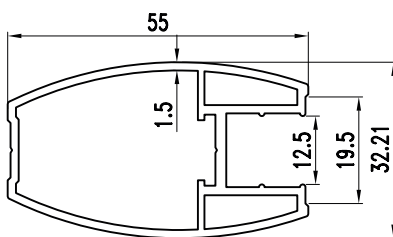

BG-052

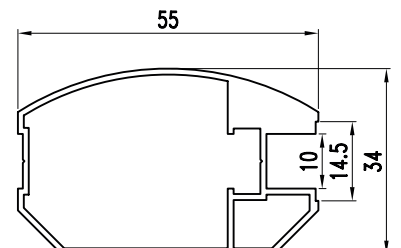

MK-269

Vertikale Profile für Schiebetür-Systeme

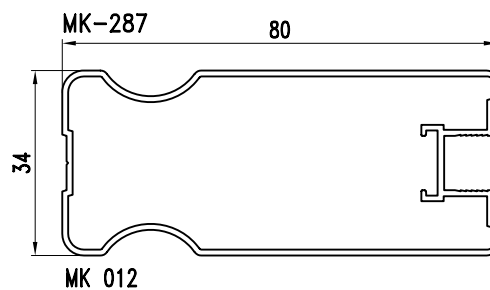
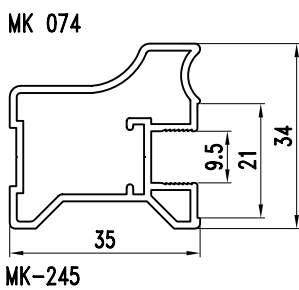
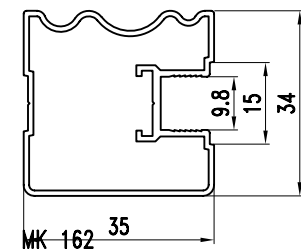
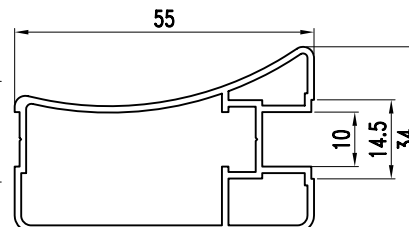
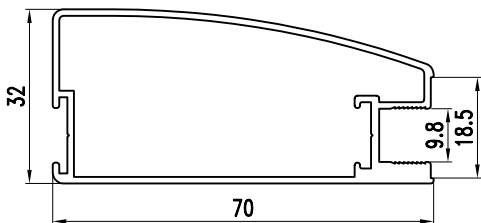
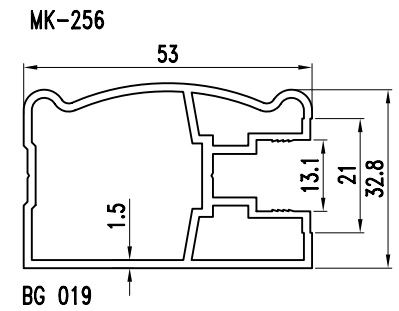
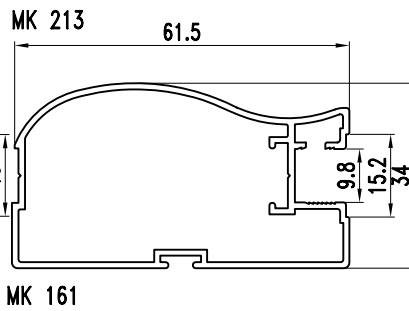
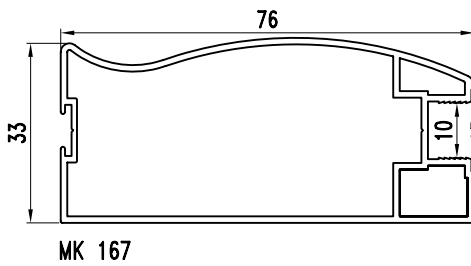
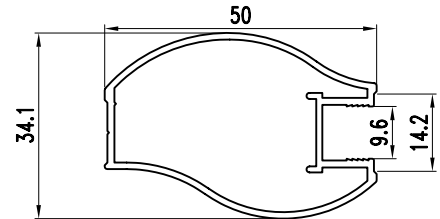
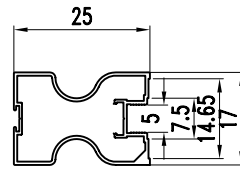
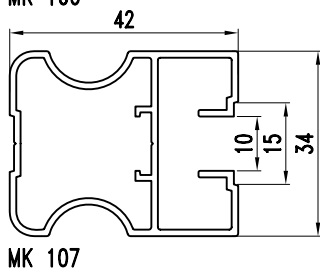
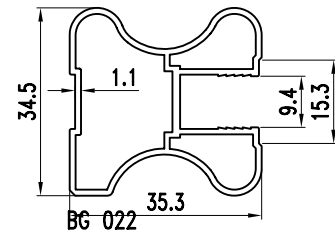
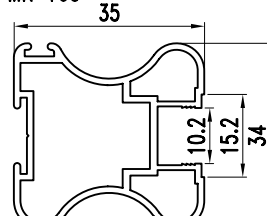
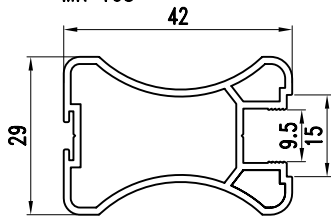
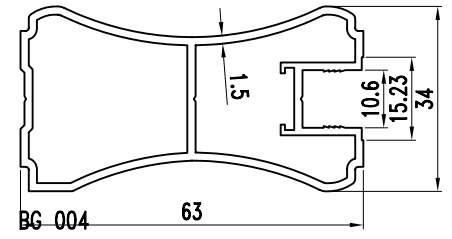
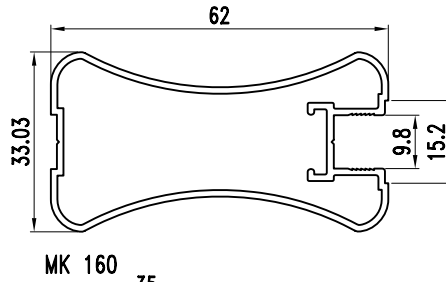
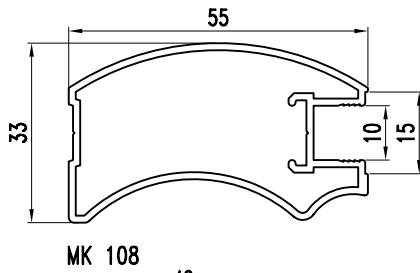
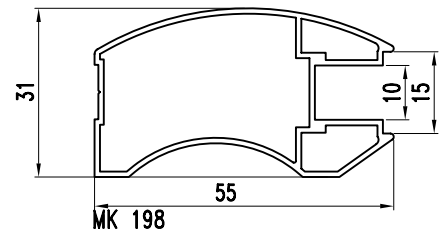
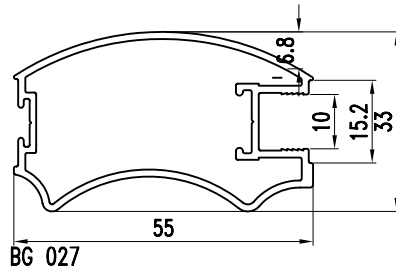
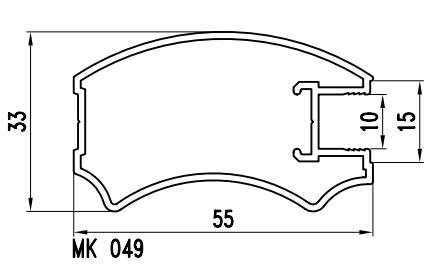

Vertikale Profile für Schiebetür-Systeme

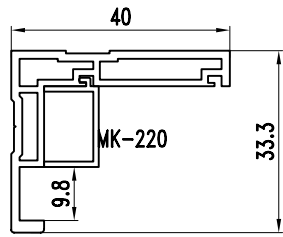

MK-219

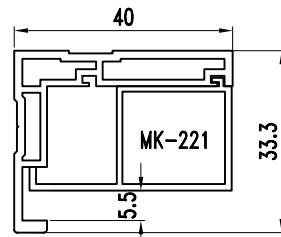

MK-219

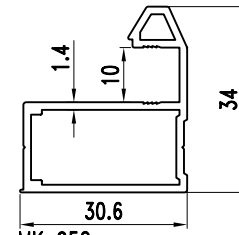

MK 052

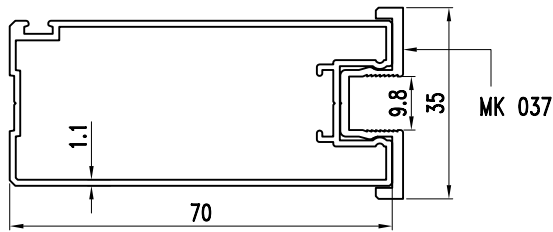

MK 036

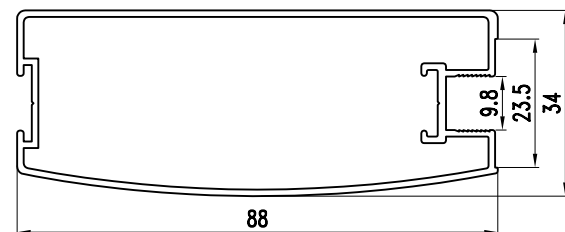

MK 132

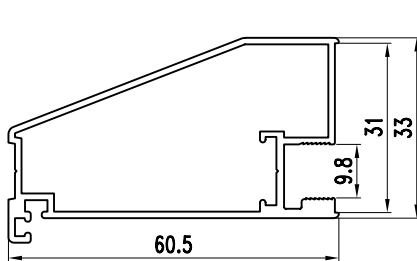

MK 079

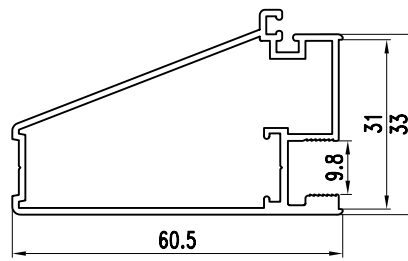

MK 080

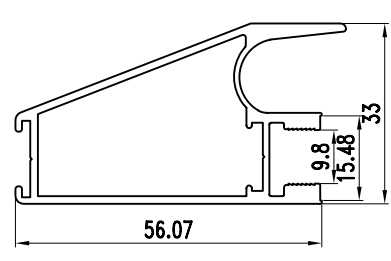

MK 081

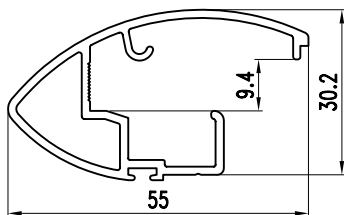

MK 173

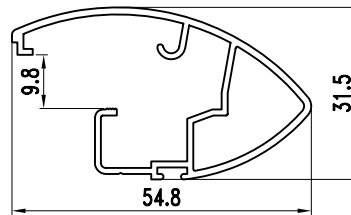

MK 175

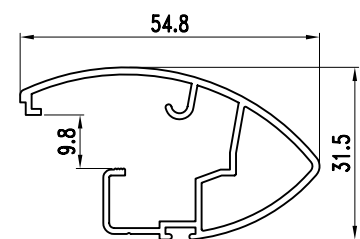

MK-257

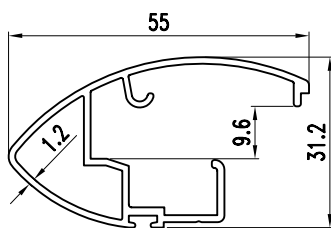

MK 007

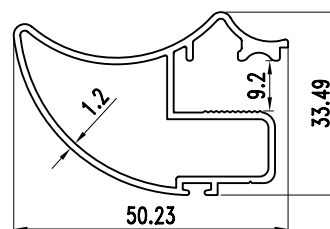

MK 008

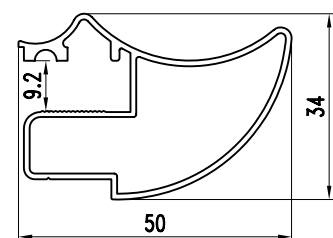

MK 181

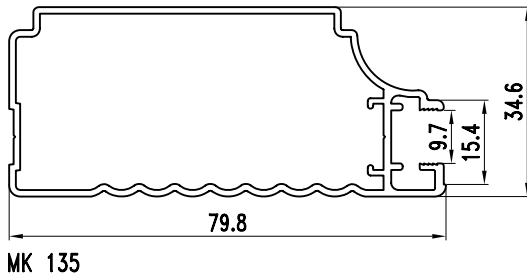

MK 135

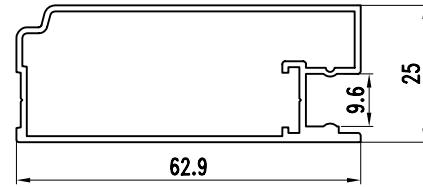

MK 140

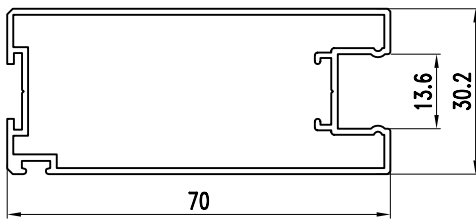

MK-286

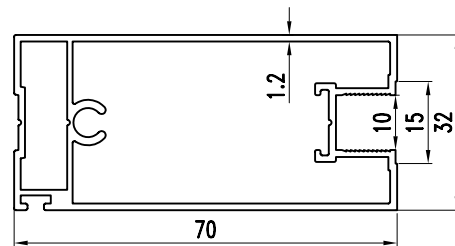

MK 042

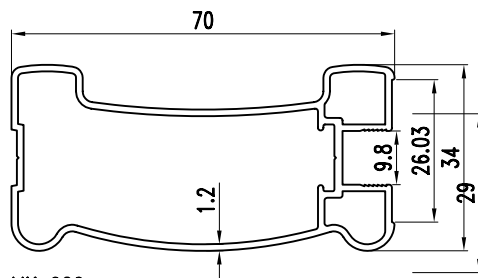

MK 020

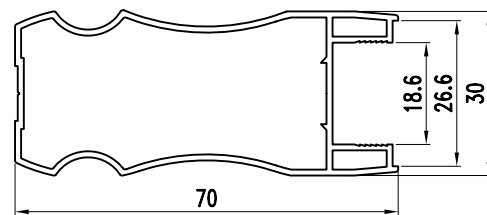

MK-276

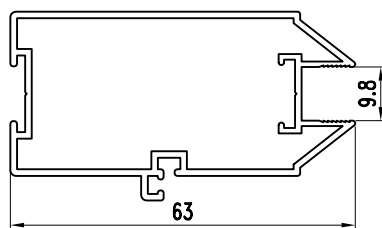

MK 115

Vertikale Profile für Schiebetür-Systeme

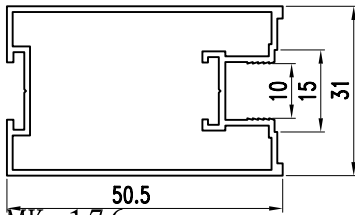

MK 176

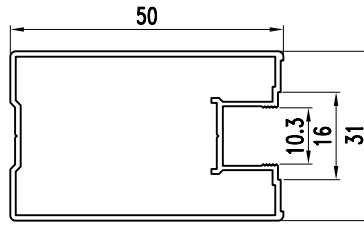

MK-277

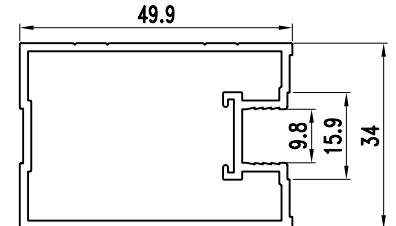

MK 200

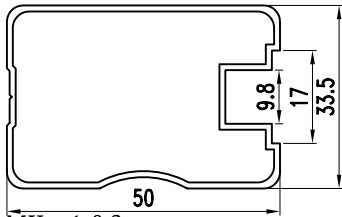

MK 109

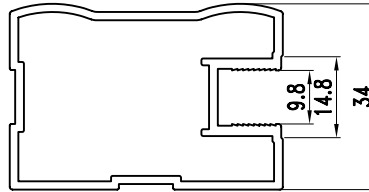

MK 202

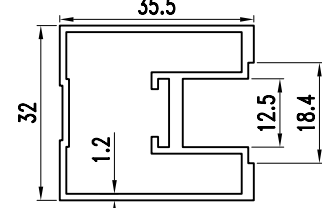

BG 018

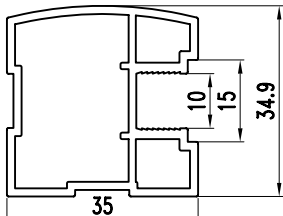

MK 201

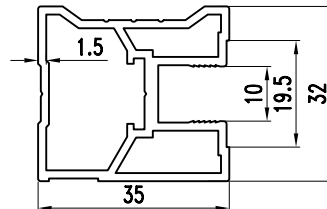

BG-038

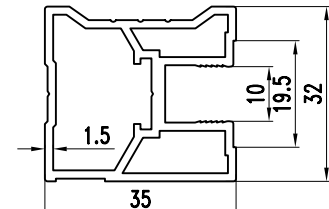

BG-049

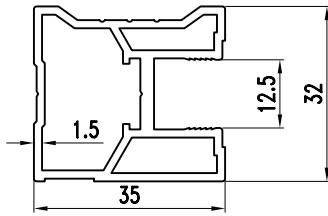

BG-039

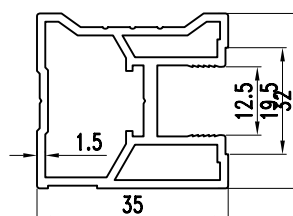

BG-050

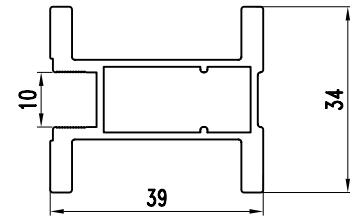

BG-055

Verbindungs-Profile für Schiebetür-Systeme

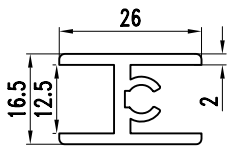

BG 007

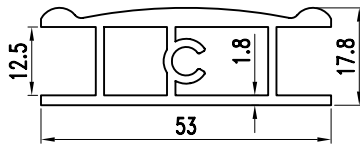

BG 008

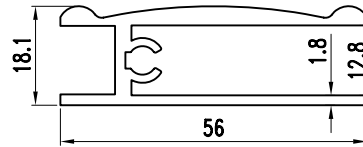

BG 009

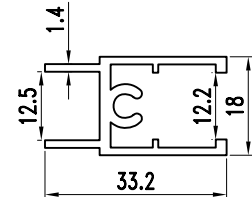

BG 013

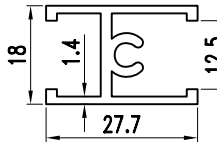

BG 014

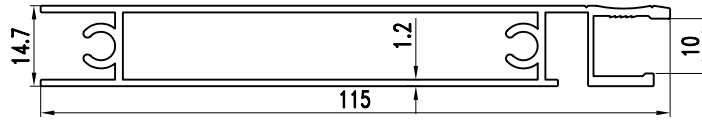

BG 010

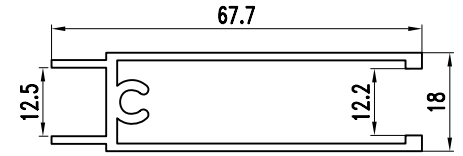

BG 015

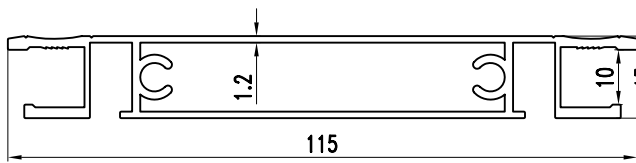

BG 011

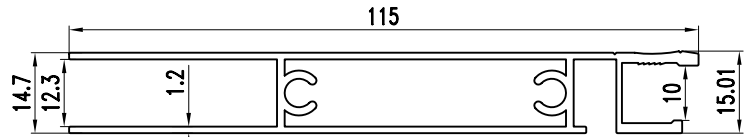

BG 012

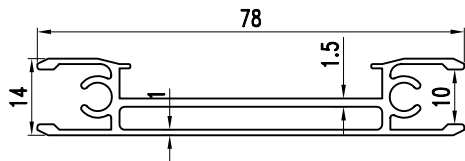

BG 024

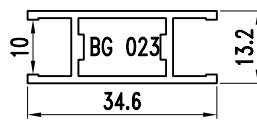

BG 023

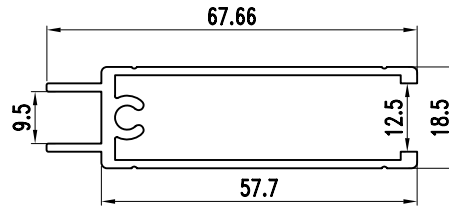

BG-032

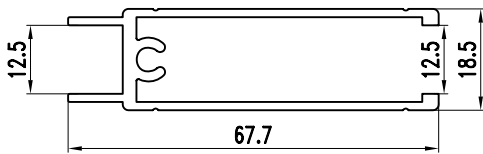

BG-033

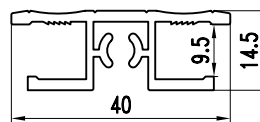

BG 026

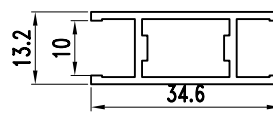

BG 023

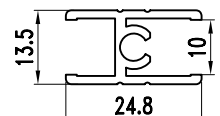

BG-028

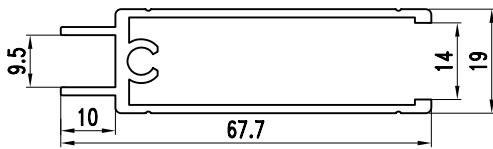

BG-036

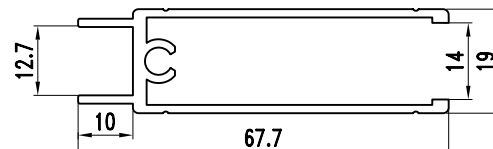

BG-037

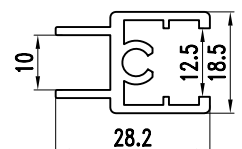

BG-029

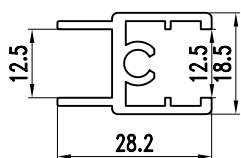

BG-030

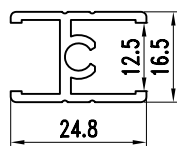

BG-031

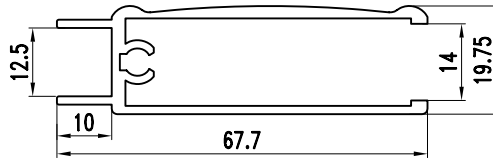

BG-042

Verbindungs-Profile für Schiebetür-Systeme

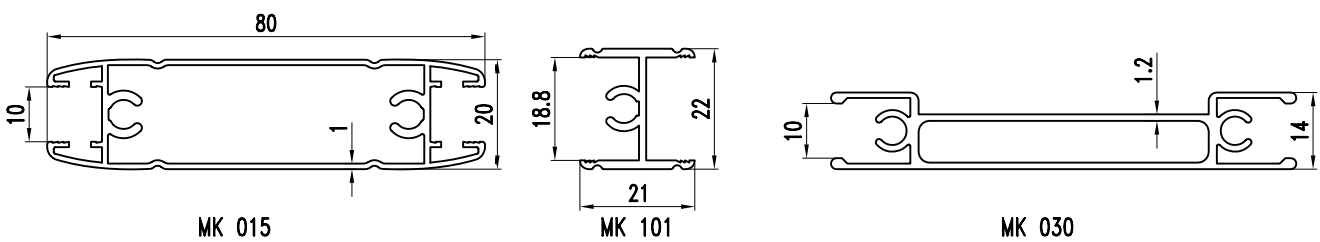
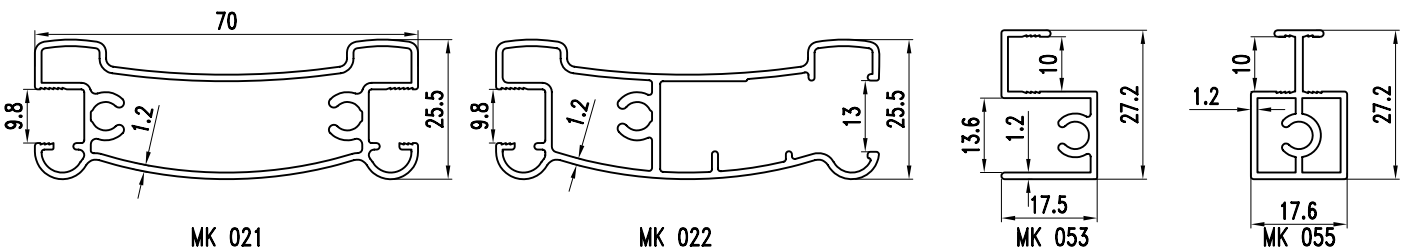
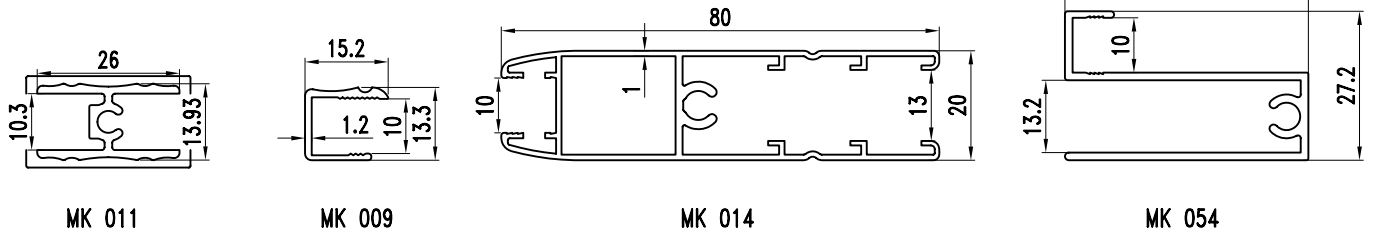
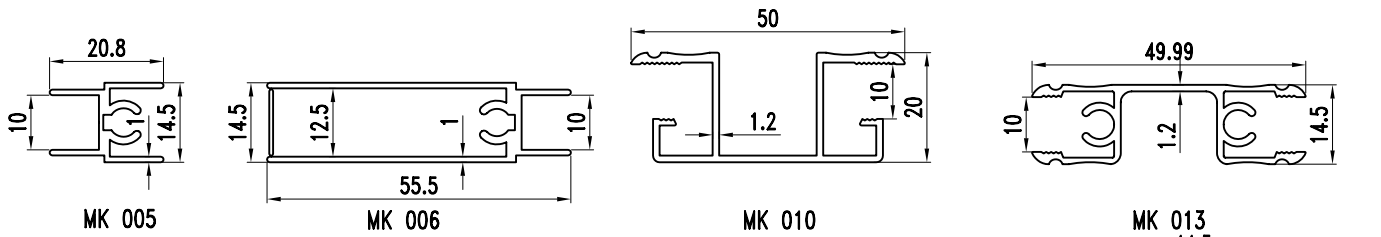
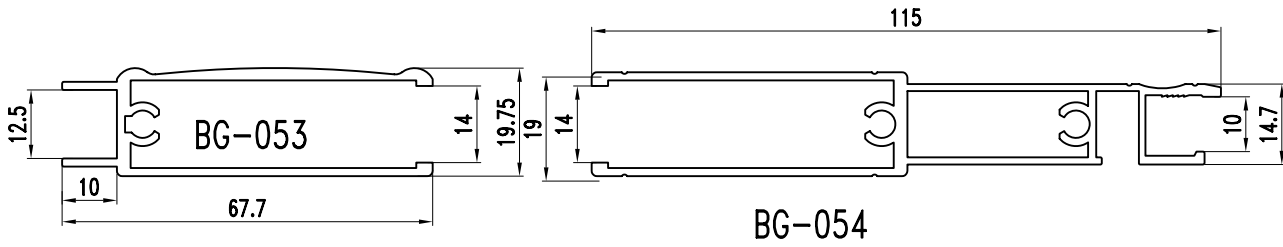
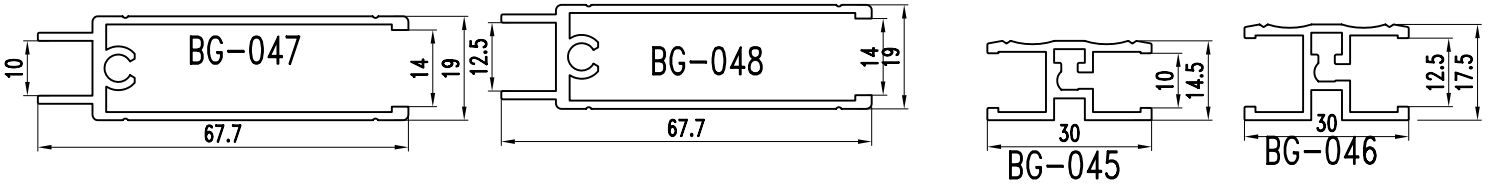
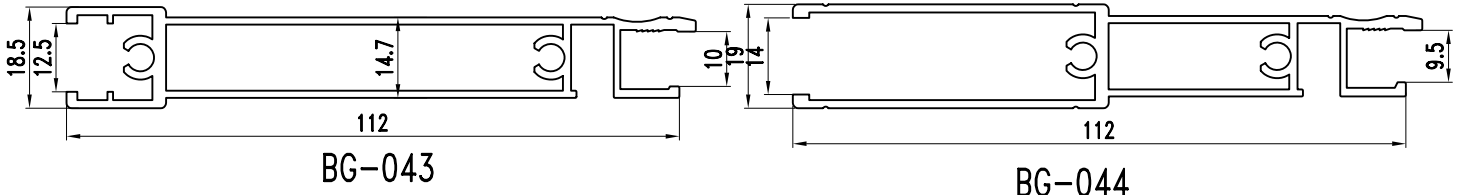

Verbindungs-Profile für Schiebetür-Systeme

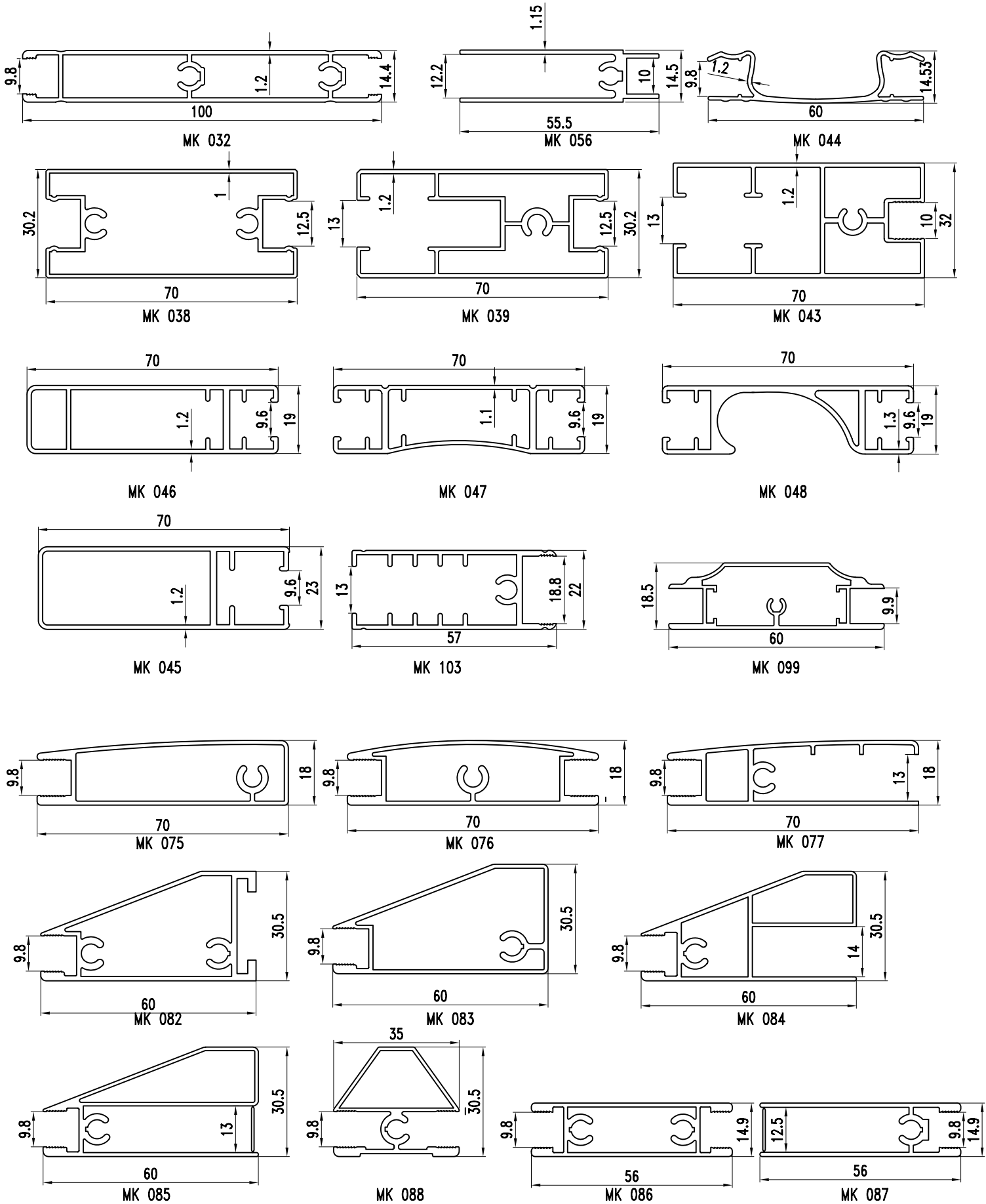

Verbindungs-Profile für Schiebetür-Systeme

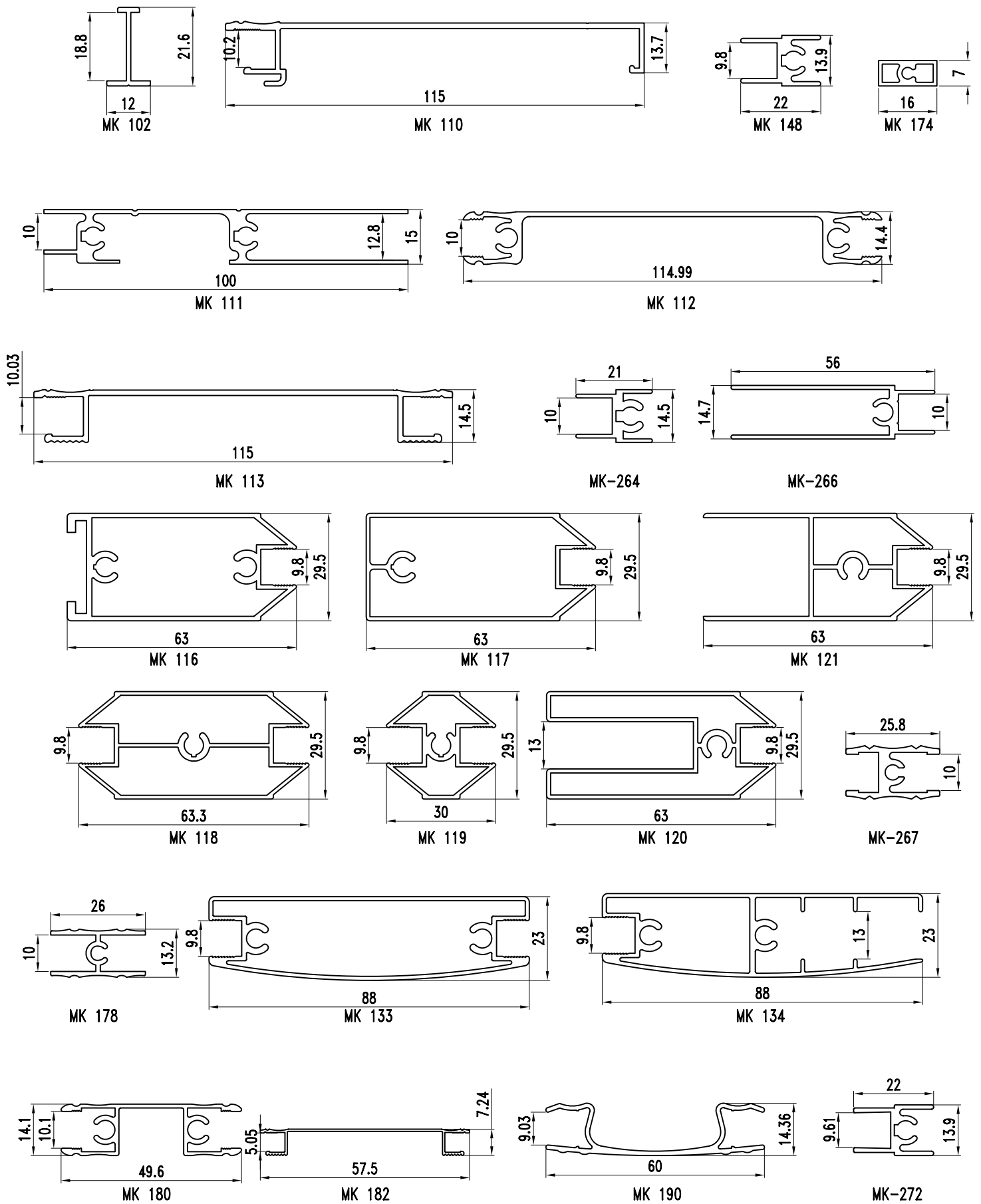

Verbindungs-Profile für Schiebetür-Systeme

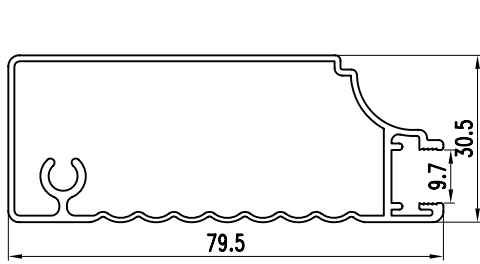

MK 136

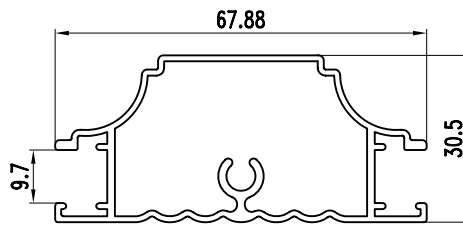

MK 137

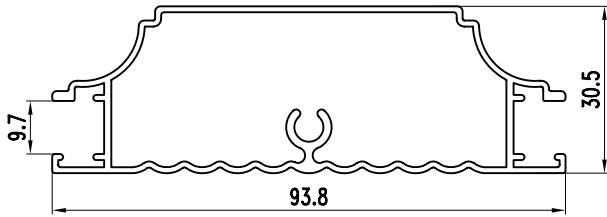

MK 138

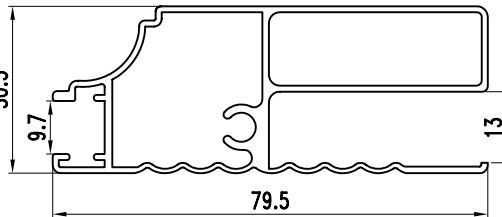

MK 139

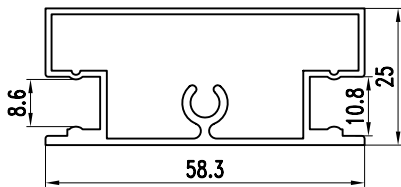

MK 141

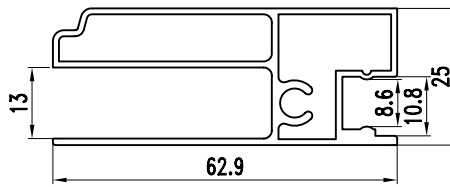

MK 142

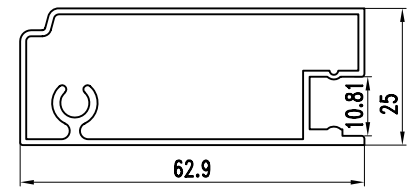

MK 143

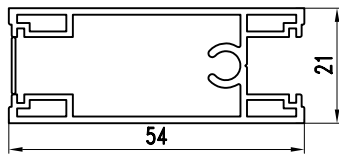

MK 206

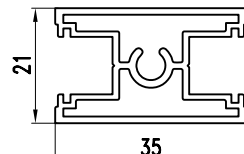

MK 205

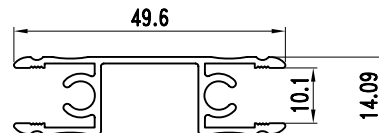

MK-260

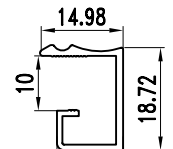

MK-261

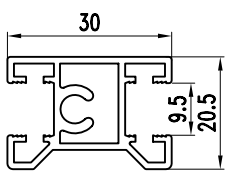

MK-246

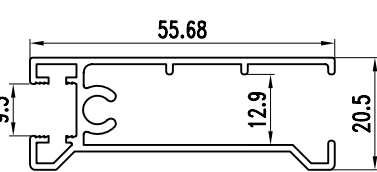

MK-247

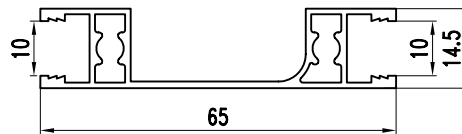

MK-250

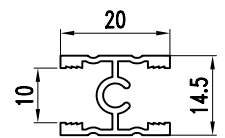

MK-252

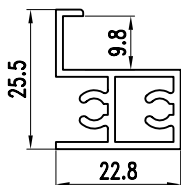

MK 215

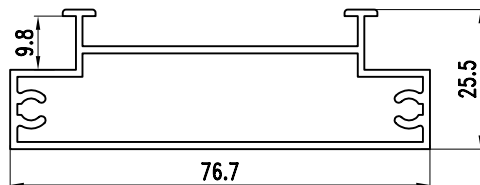

MK 216

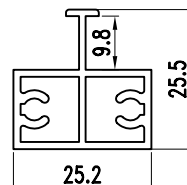

MK 218

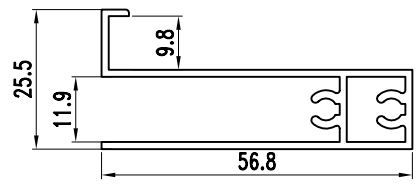

MK 217

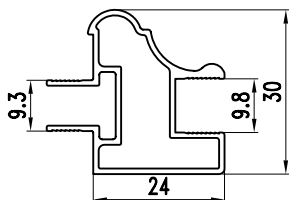

MK-223

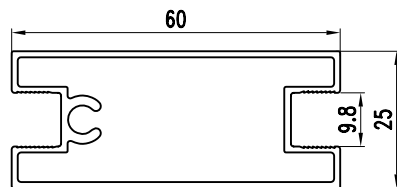

MK-224

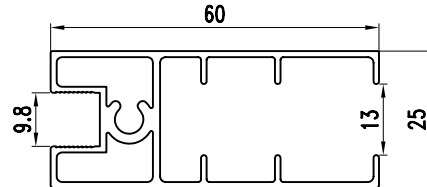

MK-225

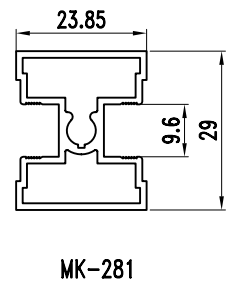
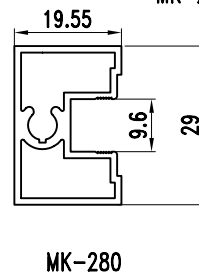
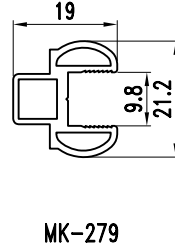
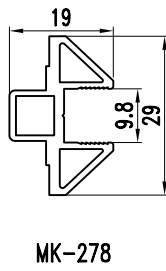
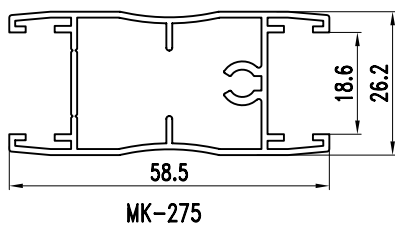
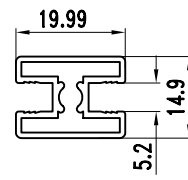
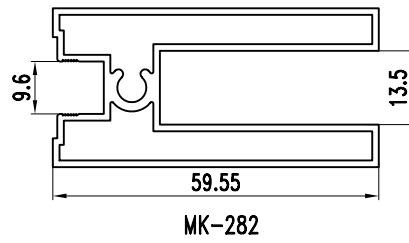
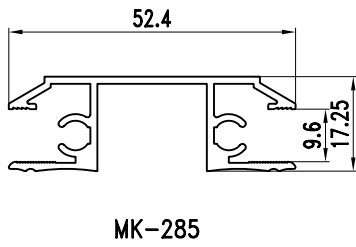
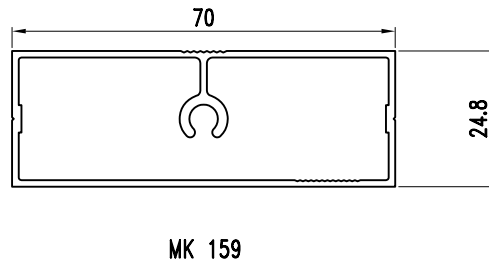
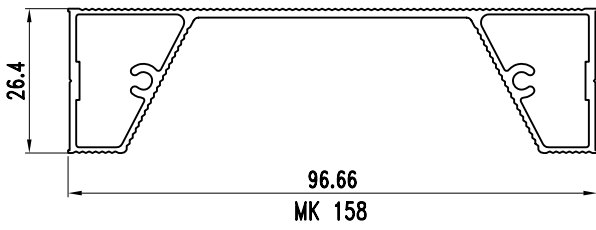
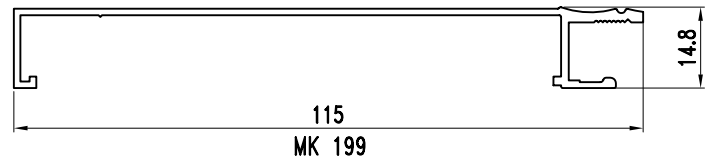
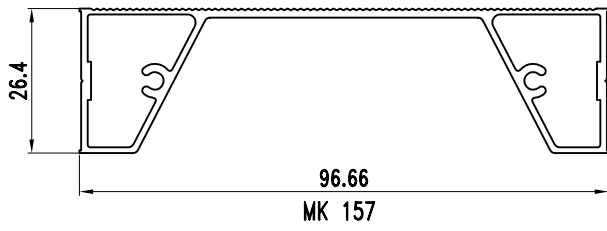
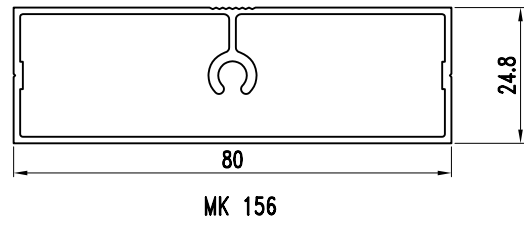
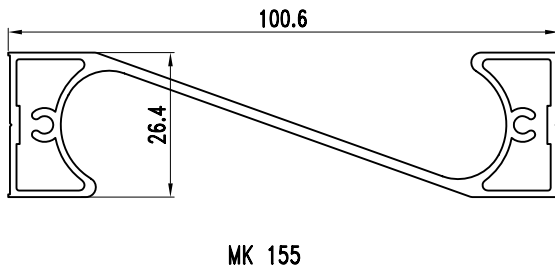
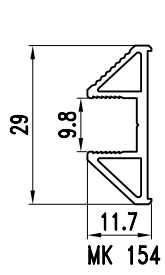

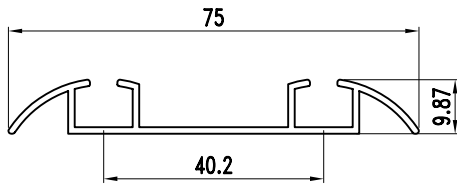

BG 017
82.19

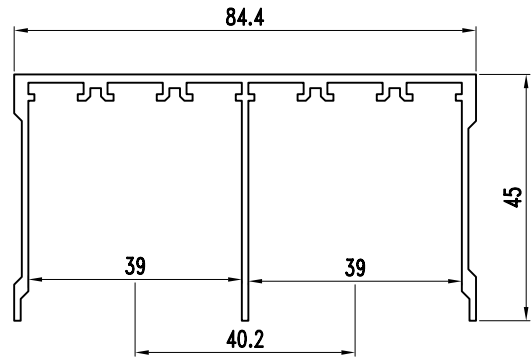

BG 016
84.4

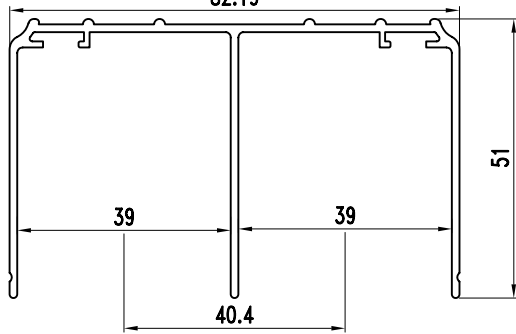

MK 016

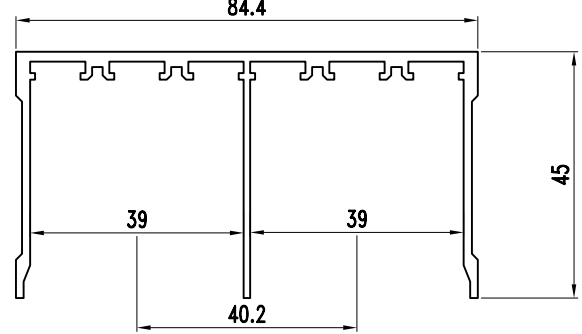

BG-034

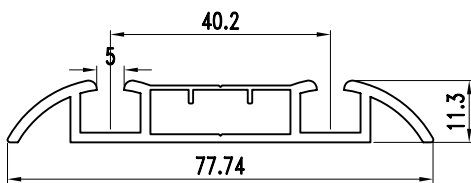

BG-035

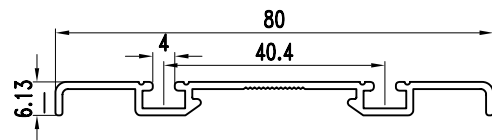

MK 017

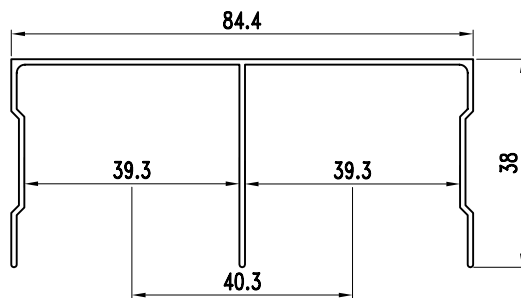

MK 018

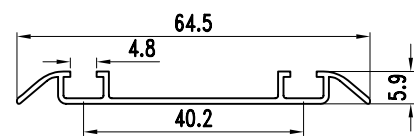

MK 019

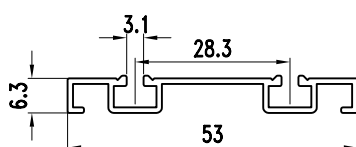

MK 152

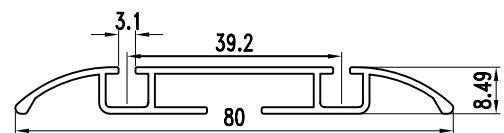

MK 149

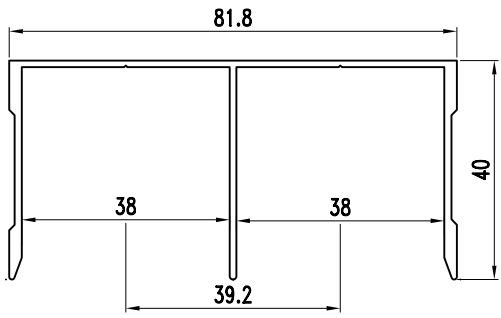

MK 150

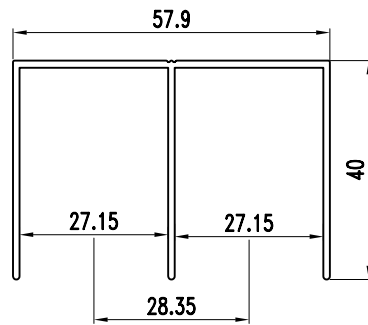

MK 151

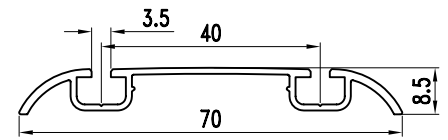

MK 183

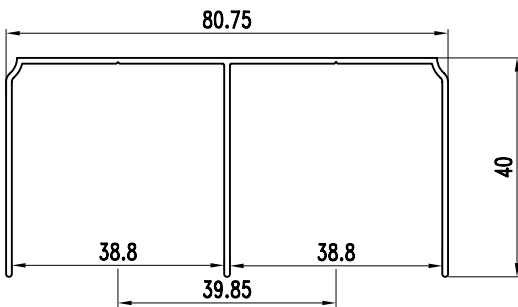

MK 184

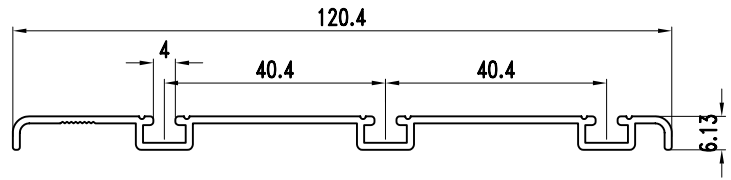

MK 093

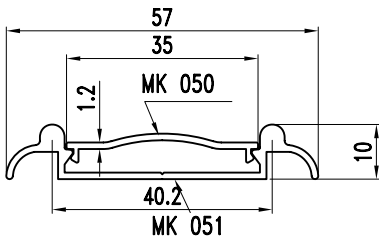

MK 051

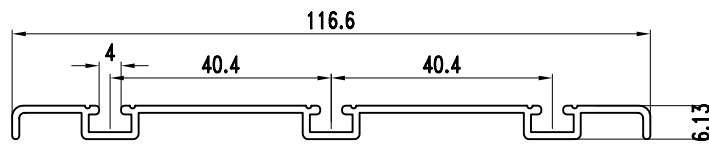

MK 189

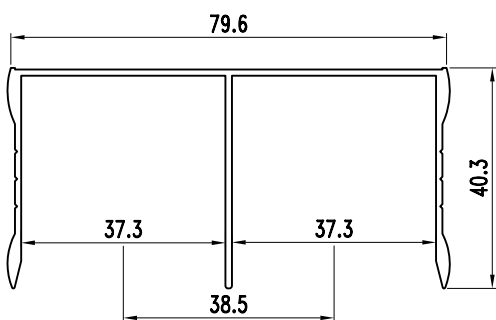

MK 191

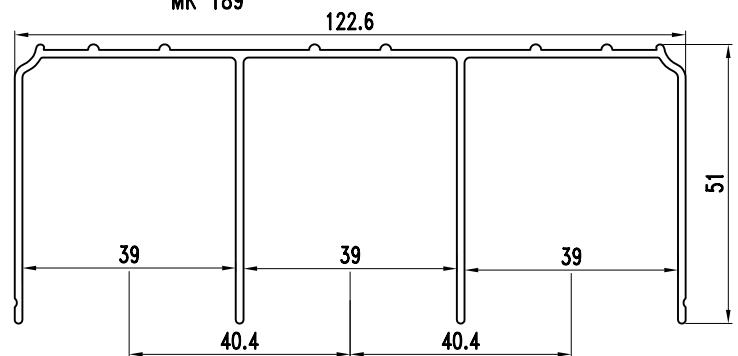

MK 092

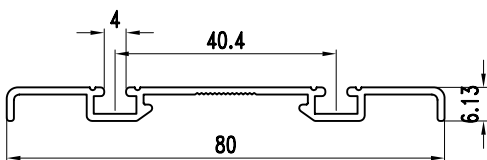

MK-249

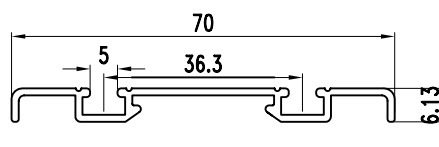

MK 123

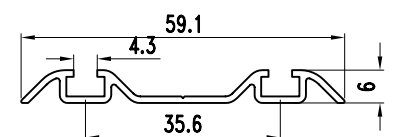

MK-255

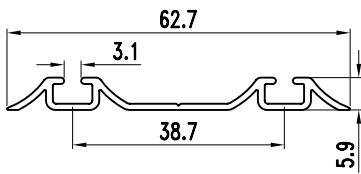

MK-236

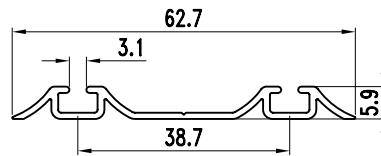

MK 192

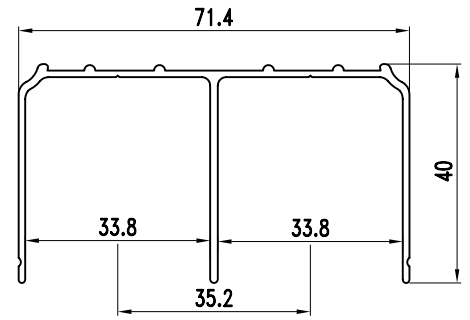

MK-226

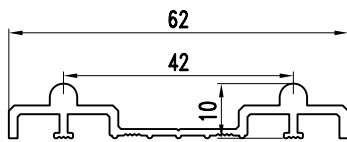

MK 073

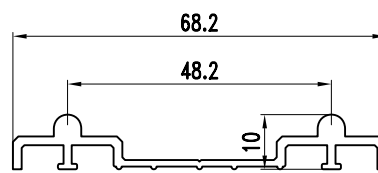

MK 067

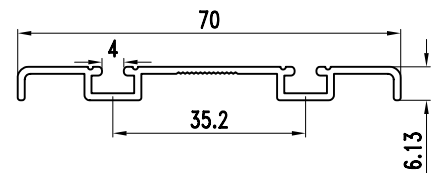

MK-227

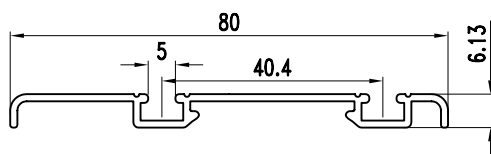

MK 091

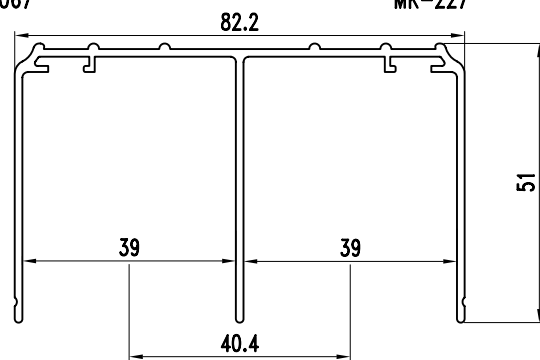

MK-248

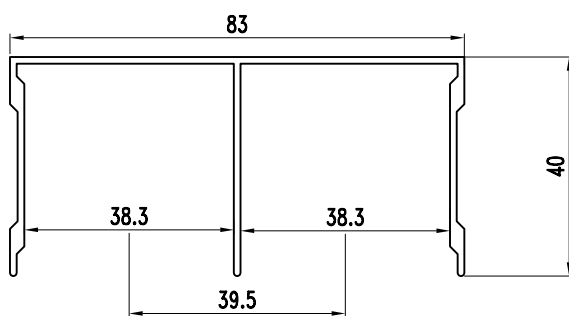

MK 185

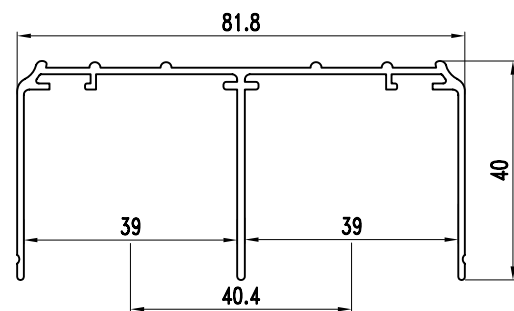

MK 090

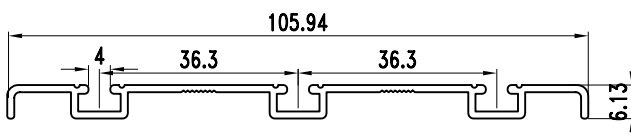

MK 125

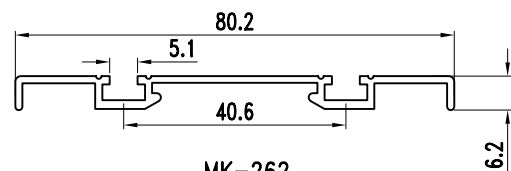

MK-262

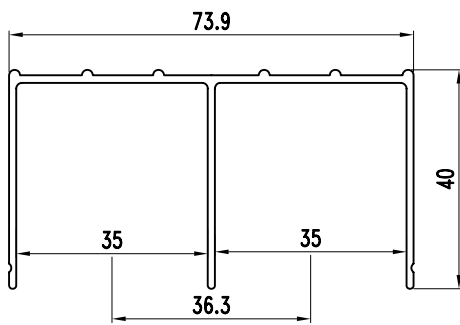

MK 122

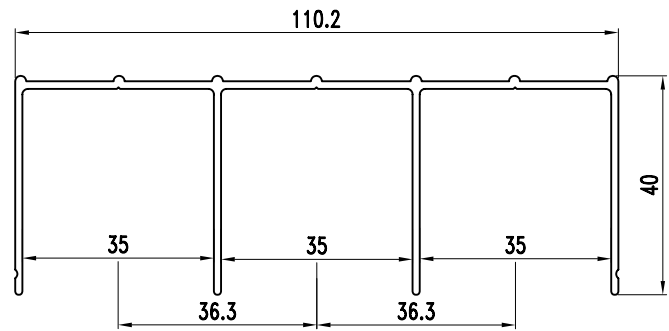

MK 127

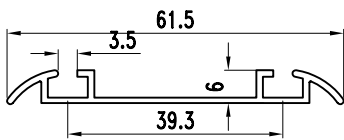

MK-251

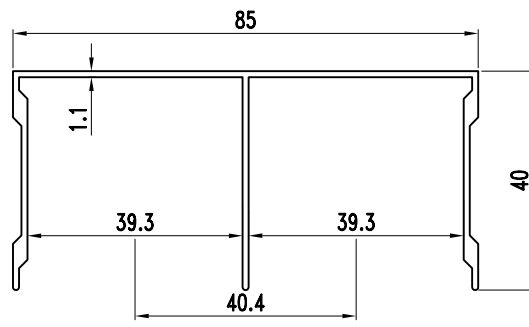

MK-253

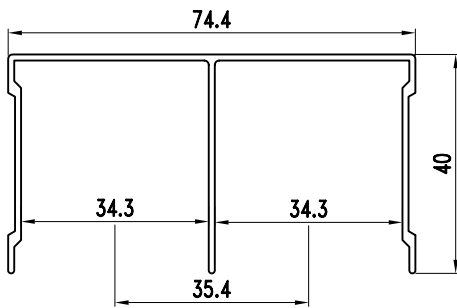

MK-254

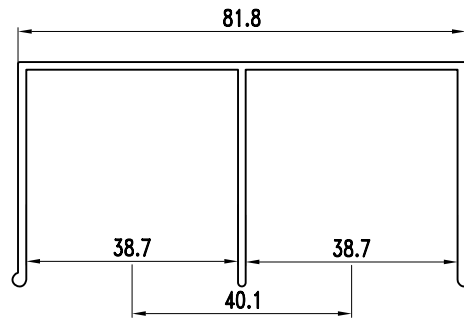

MK-263

Alu-Griffleisten

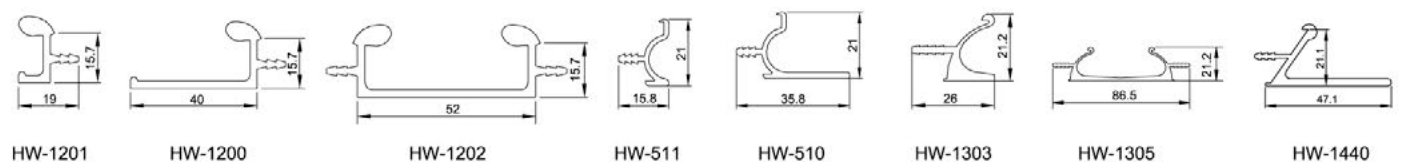
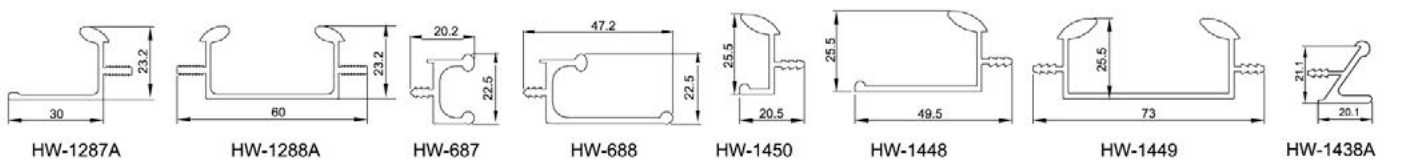
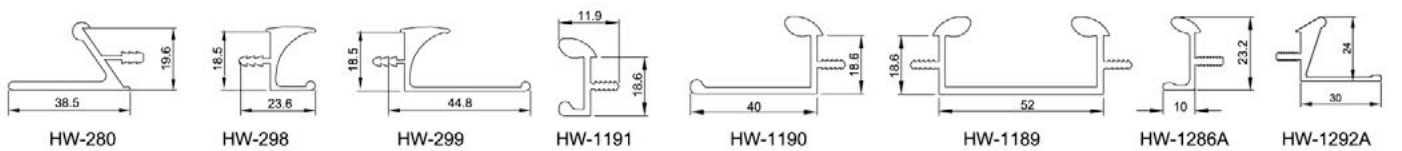
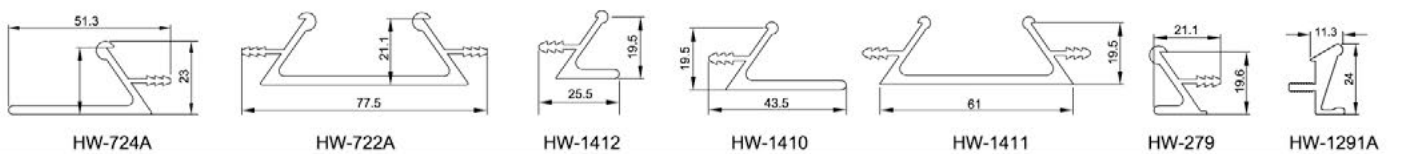
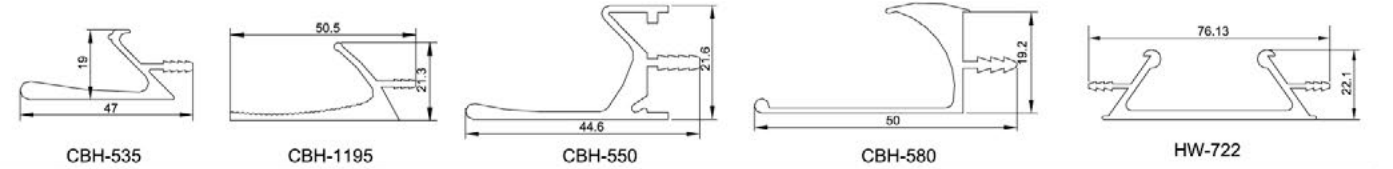
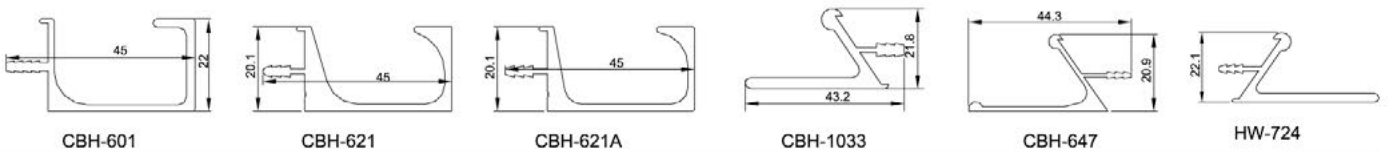
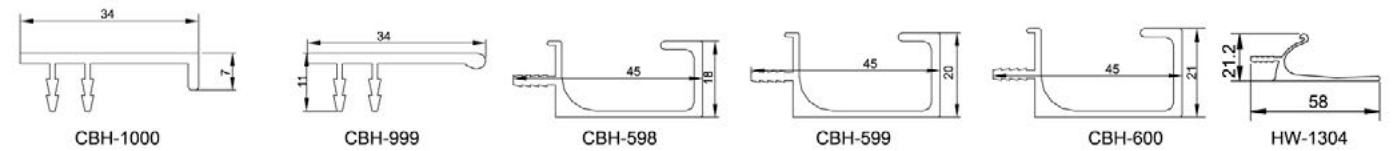
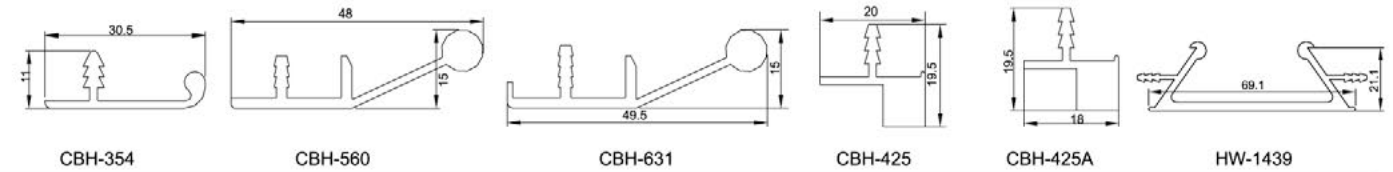
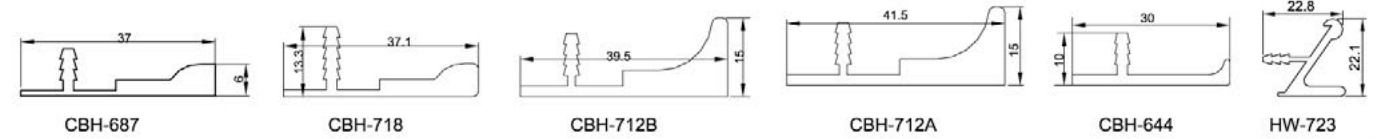
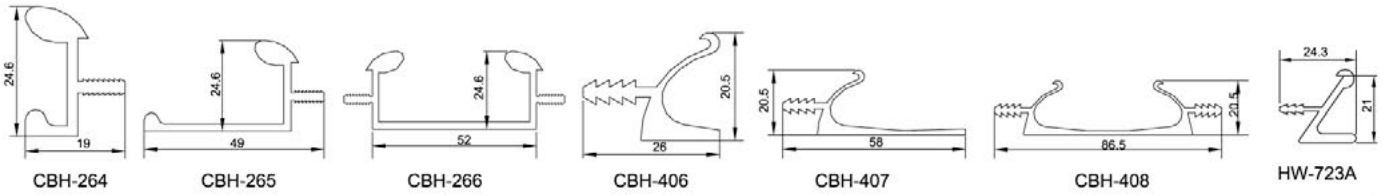

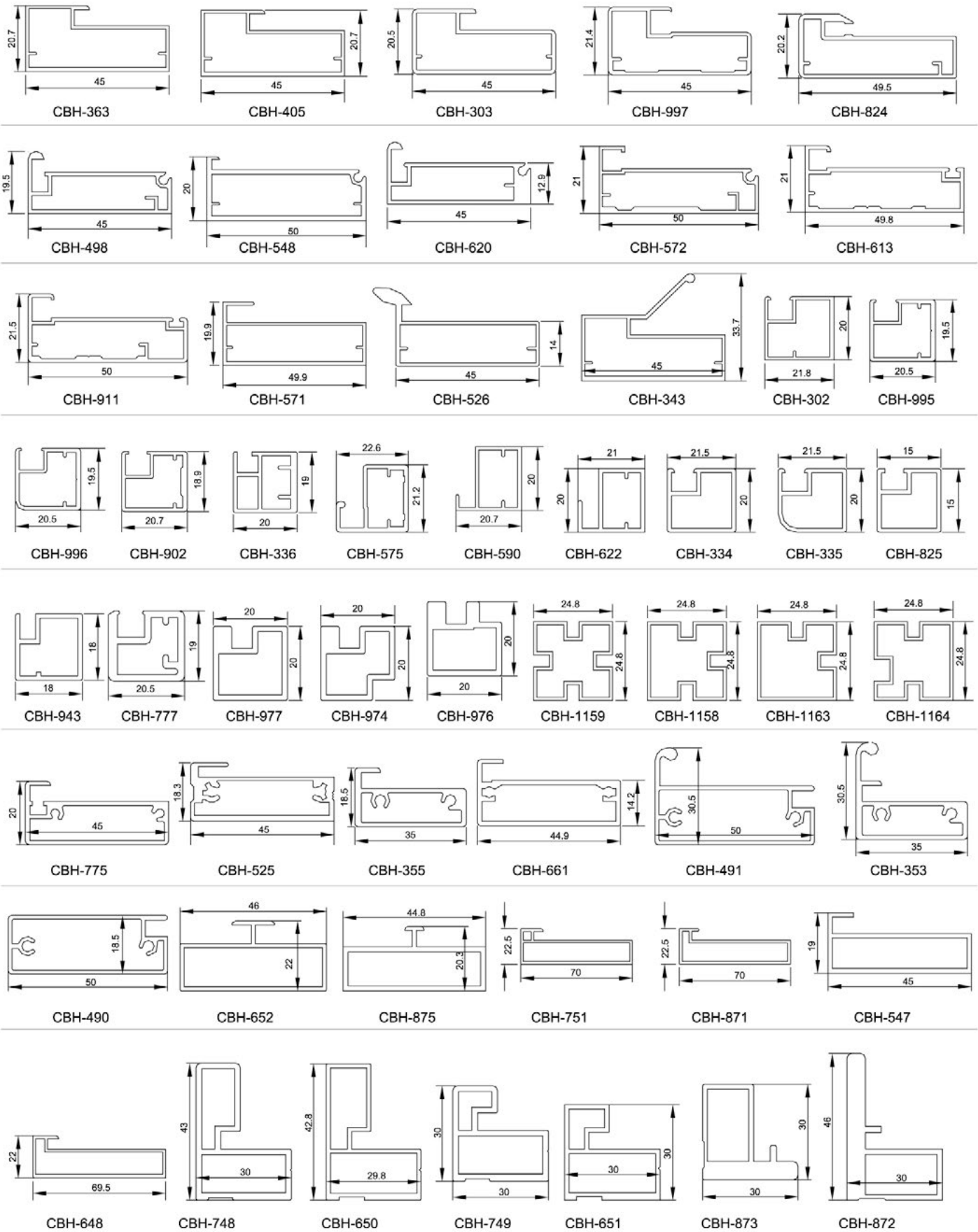

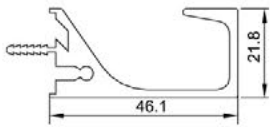

HW-1086

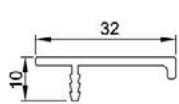

HW-354

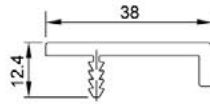

HW-367

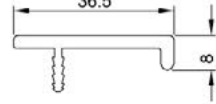

HW-937

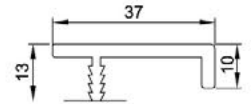

HW-845

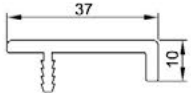

HW-935

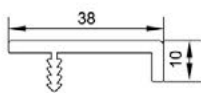

HW-1491

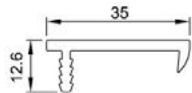

HW-826

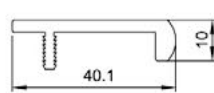

HW-1297A

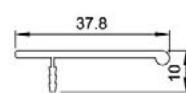

HW-527

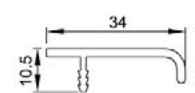

HW-047

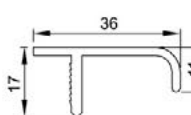

HW-097

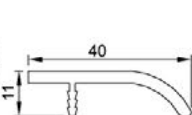

HW-781

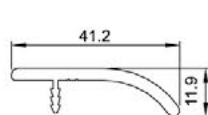

HW-807

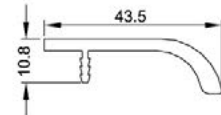

HW-1392

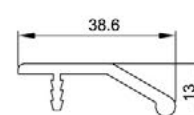

HW-053

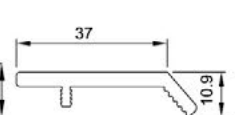

HW-220

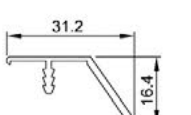

HW-1459

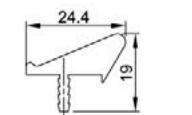

HW-185

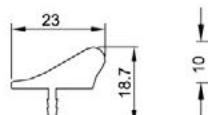

HW-780

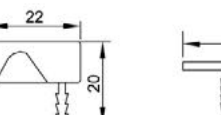

HW-1245

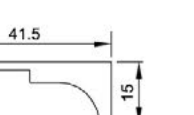

HW-712A

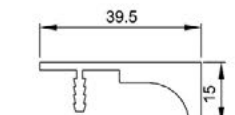

HW-712B

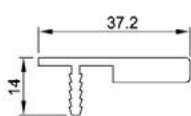

HW-579

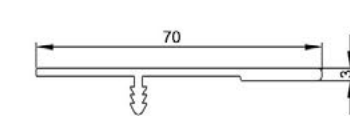

HW-1256

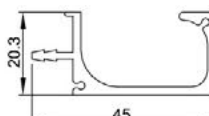

HW-327

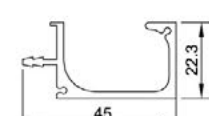

HW-327A

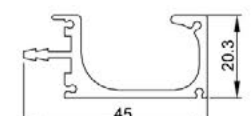

HW-488

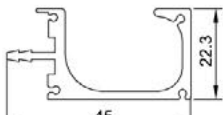

HW-487

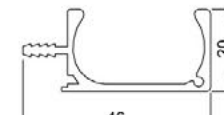

HW-508

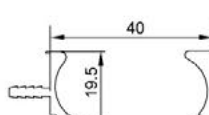

HW-736

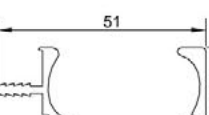

HW-559

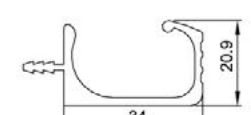

HW-586

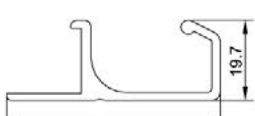

HW-958

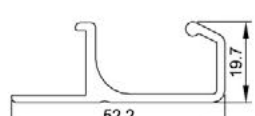

HW-821



HW-1308

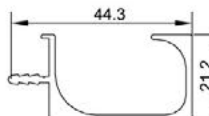

HW-1536

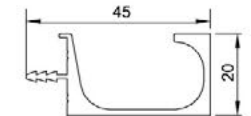

HW-914

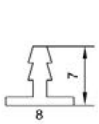
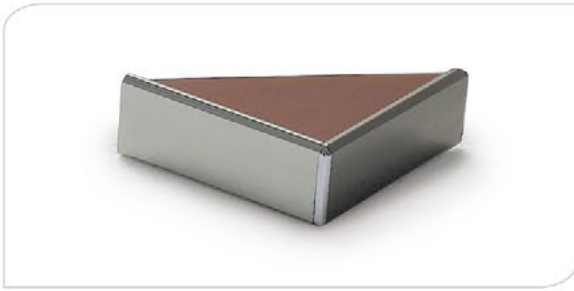

HW-180

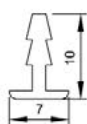

HW-331

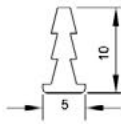

HW-276

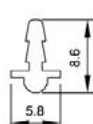

HW-274

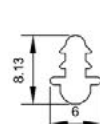

HW-1004

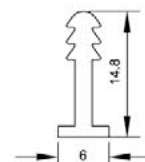

HW-1276

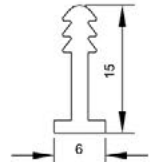

HW-1277

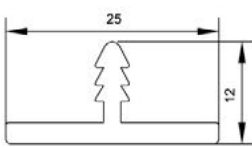

HW-1253

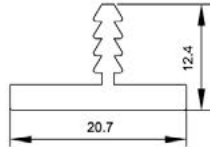

HW-1347

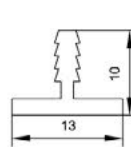

HW-009

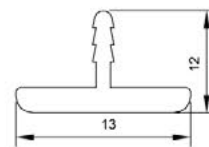

HW-797

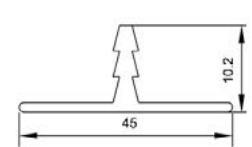

HW-266

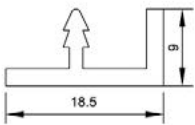

HW-102

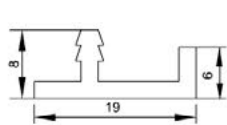

HW-059

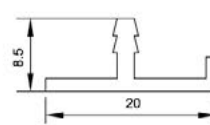

HW-672

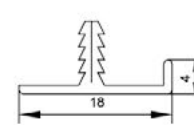

HW-1111

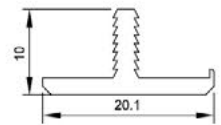

HW-816

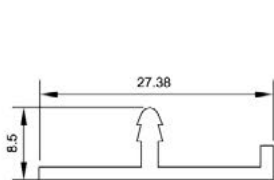

HW-751

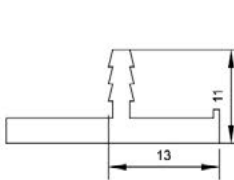

HW-591

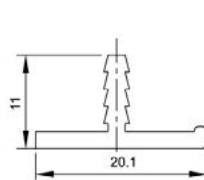

HW-184

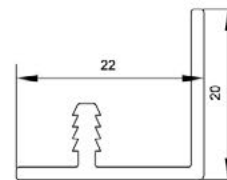

HW-1515

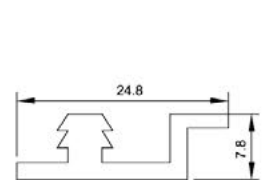

HW-335

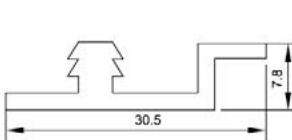

HW-855

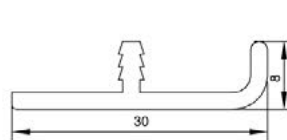

HW-686

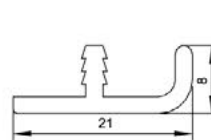

HW-690

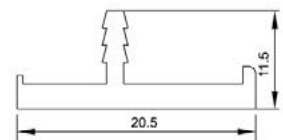

HW-120

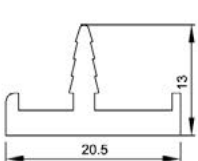

HW-121

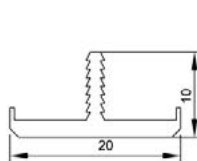

HW-355

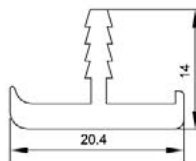

HW-558

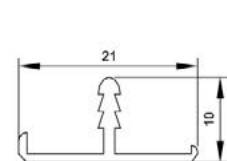

HW-574

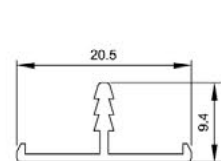

HW-772

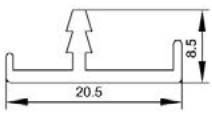

HW-1066

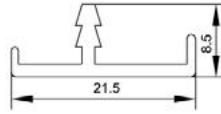

HW-1066A

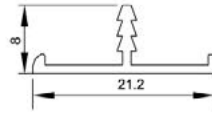

HW-1313

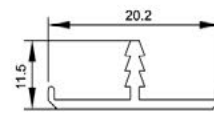

HW-1314

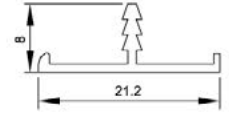

HW-1346

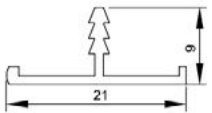

HW-1407

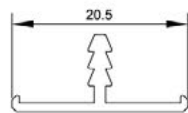

HW-1458

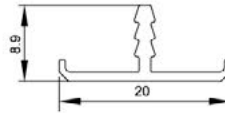

HW-1437

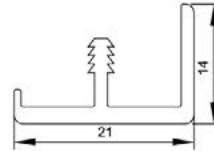

HW-1454

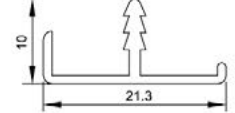

HW-733

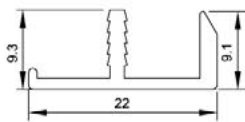

HW-236

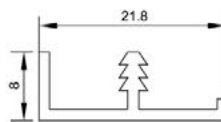

HW-931

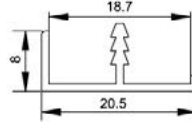

HW-1408

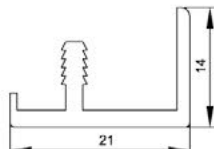

HW-1342

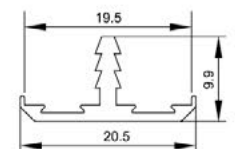

HW-1279

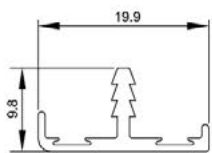

HW-1531

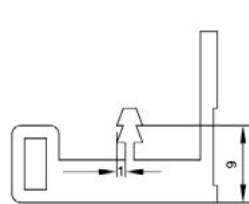

HW-799

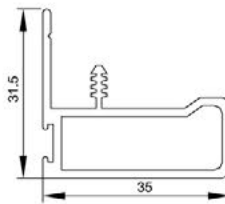

CBH-436

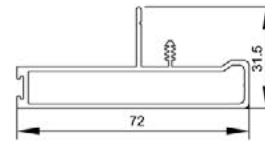

CBH-435

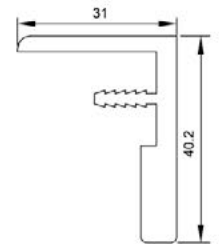

HW-581

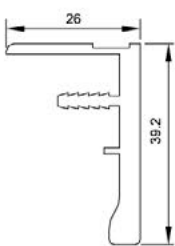

HW-837

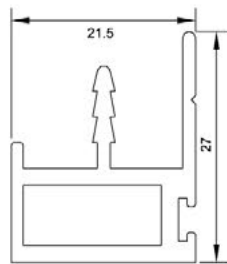

HW-820

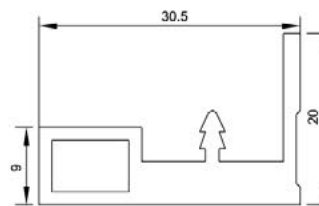

HW-101

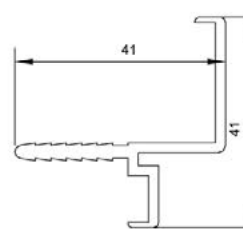

HW-715

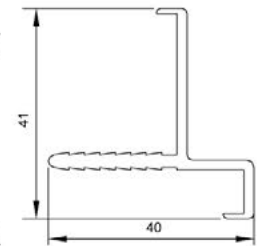

HW-716

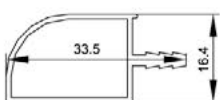

CBH-619

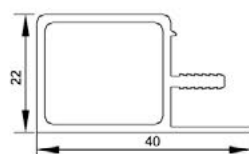

CBH-920

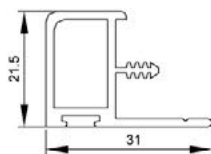

CBH-434

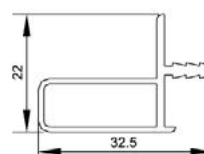

CBH-993

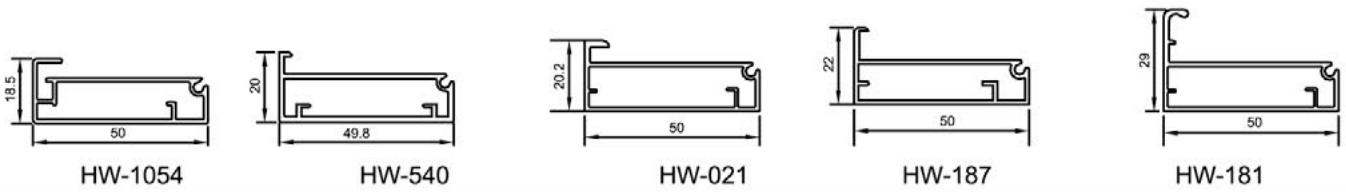
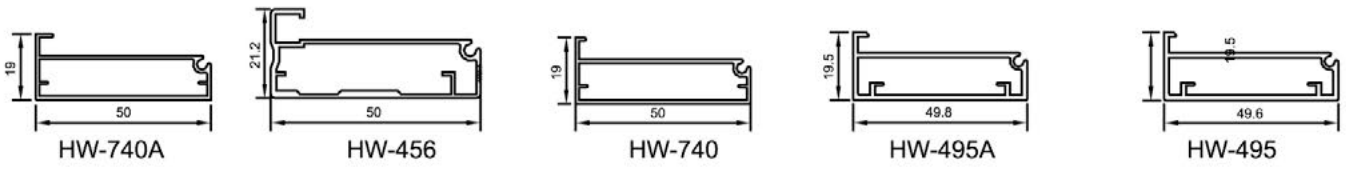
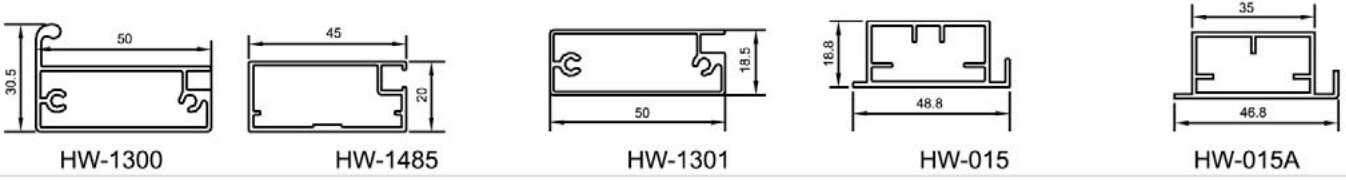
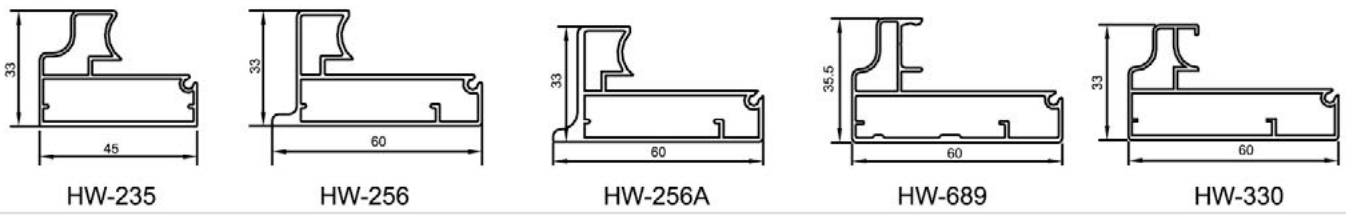
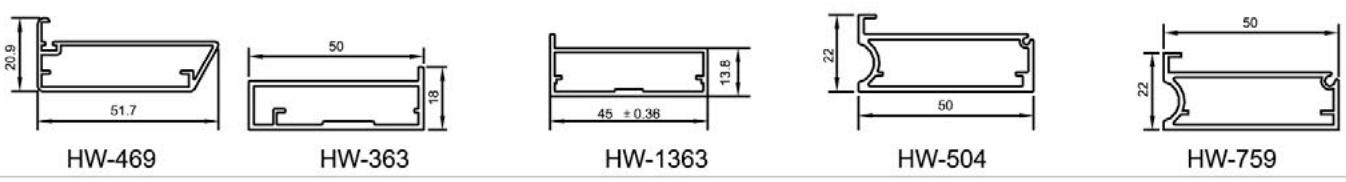
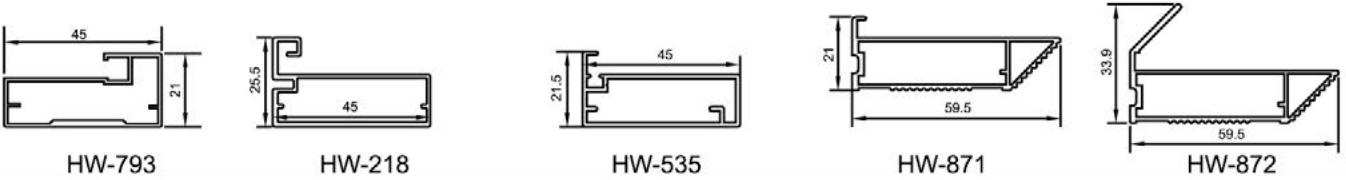
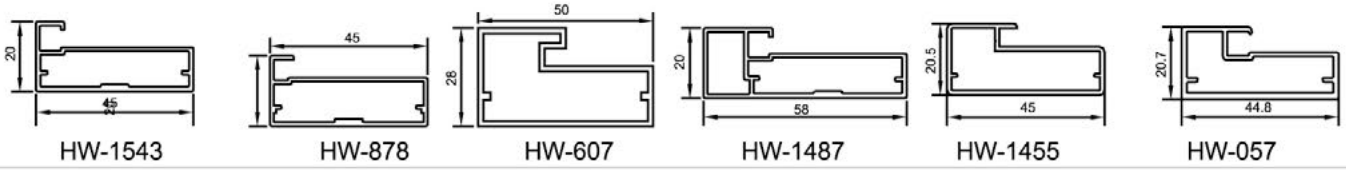
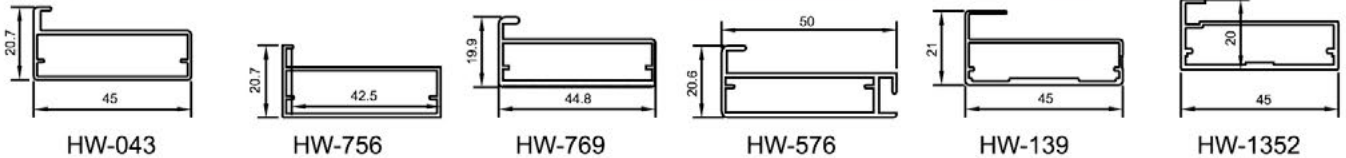
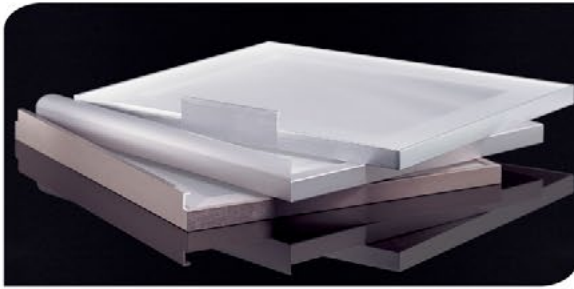

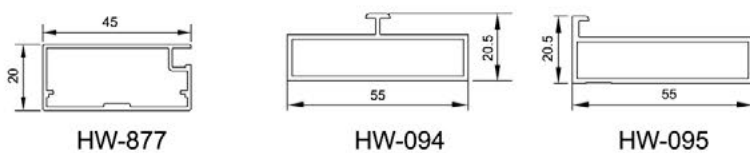
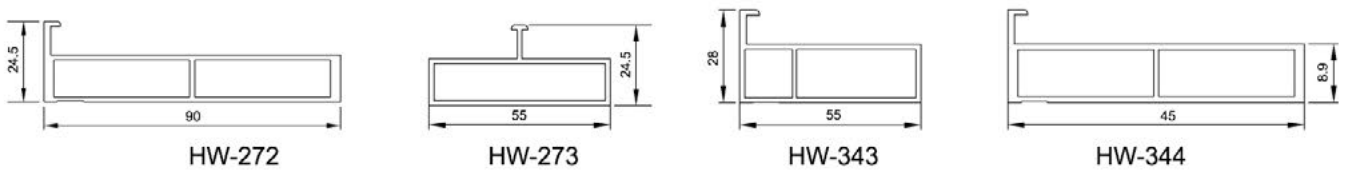
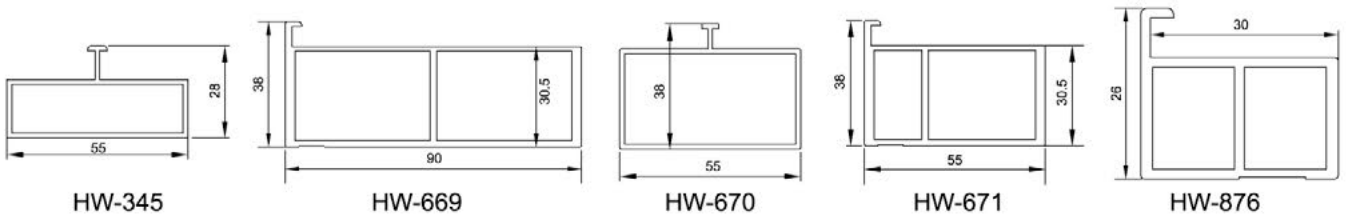
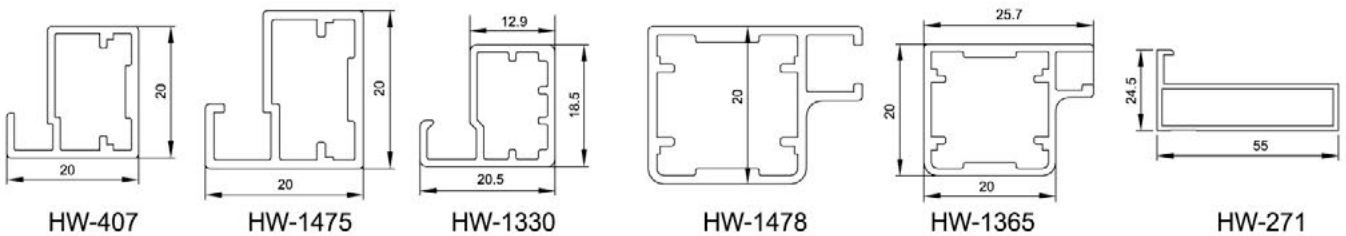
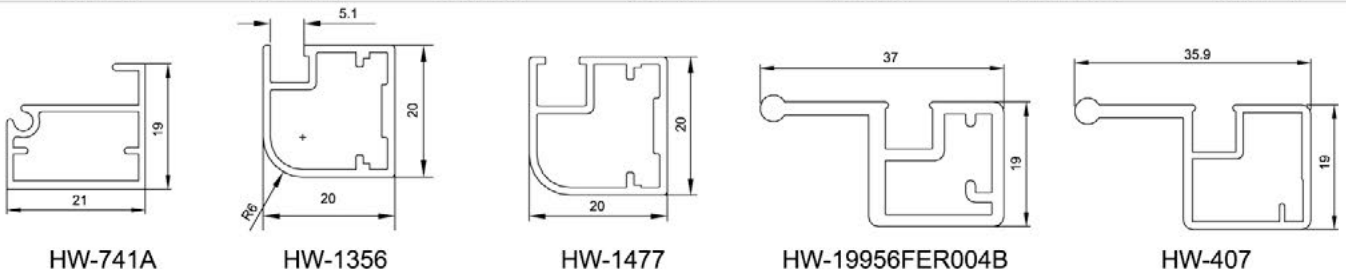
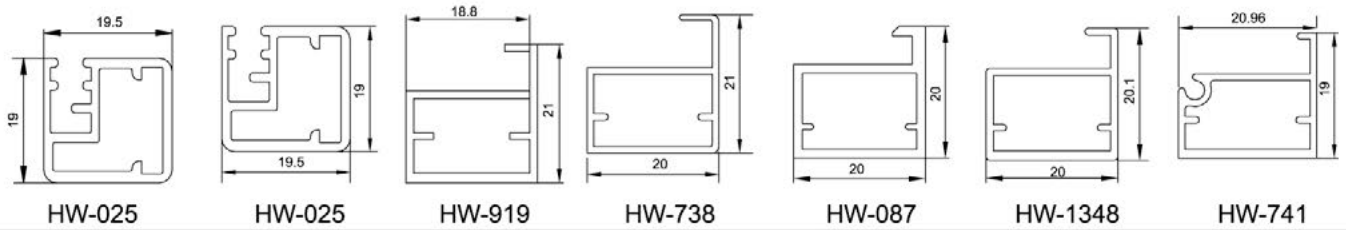
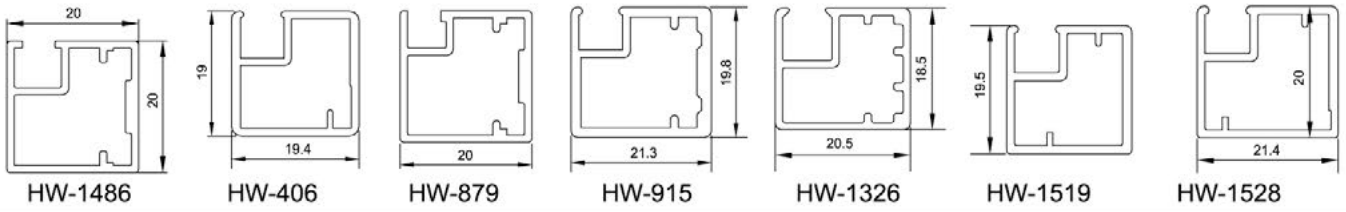
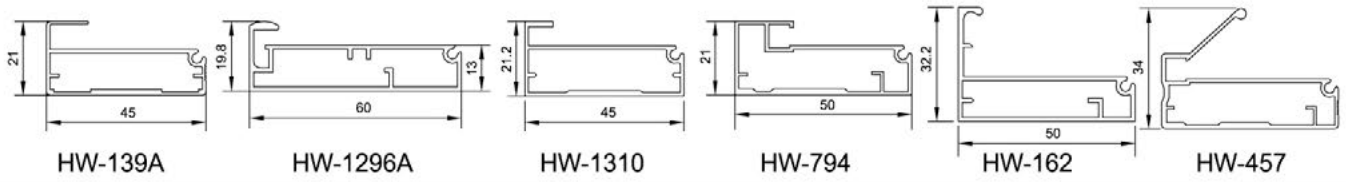



osa GmbH & Co. KG
Am Tyrol 21
D-58636 Iserlohn

Tel.: +49 2371 78888-0
Fax: +49 2371 78888-19
Mail: osa@o-s-a.de
Web: www.o-s-a.de